



GOVERNMENT OF ODISHA,
DEPARTMENT OF WATER RESOURCES,
OIIAWMIP, 5th FLOOR, RAJIV BHAWAN, BHUBANESWAR - 751001

ODISHA INTEGRATED IRRIGATED AGRICULTURE AND WATER MANAGEMENT
INVESTMENT PROGRAMME FOR IMPLEMENTATION OF MLIPs FUNDED BY OFID OUT OF
MULTI TRANCHE FINNACING FACILITY LOAN FROM ASIAN DEVELOPMENT BANK (ADB)

QUOTATION DOCUMENTS FOR EXTERNAL ELECTRIFICATION

FOR REVIVAL / IMPROVEMENT OF
06 Nos. OF MINOR LIFT IRRIGATION PROJECTS
(UNDER TRANCHE-I)
IN **BADACHANA** BLOCK OF
JAJPUR DISTRICT

PACKAGE NO. MLI -I/ 2015- 2016

Sd/-
CE-cum-PROJECT DIRECTOR,
PROJECT MANAGEMENT UNIT (PMU)
ORISSA INTEGRATED IRRIGATED AGRICULTURE
AND
WATER MANAGEMENT INVESTMENT PROGRAMME (OIIAWMIP)

FEB. 2016

CONTENTS

Sl. No.	Section	Contents	Page No.
1.	Section - I	Instructions to Bidders	3 - 8
2.	Section – II	Terms & Conditions of Supply	9 - 11
3.	Section – III	Scope of work	12
4.	Section – IV	Price schedule for Sub- projects (06 Nos.)	13 - 18
5.	Annexure- A	List of works executed by the Quotationer	19
6.	Annexure-B – G	Technical Particulars	20 - 32
7.	Annexure – H	Drawings	33 - 38
8.	Annexure - I	List of Sub-Projects in Badachana Block of Jajpur District	39
9.	Annexure - J	Certificate of no relationship	40

Client

Signature of the Bidder

SECTION – I

INSTRUCTIONS TO BIDDERS

1.	Last date of sale of Quotation Documents:	Up to 11.30 A.M. of 10.03.2016
2.	Time and last date of receipt of Quotation:	Up to 1.30 P.M. of 10.03.2016
3.	Time and date of opening of Quotation:	At 3.30 P.M. of 10.03.2016
4.	Place at which Quotation paper will be available:	Office of the Deputy Director, Dam Safety and Support Services Bhubaneswar. Office of the EIC, Secha Sadan, Bhubaneswar.
5.	Place at which Quotation will be received:	Office of the Deputy Director, Dam Safety and Support Services Office of the EIC, Secha Sadan, Bhubaneswar / Chief Engineer-cum-Project Director, Project Management Unit, 5 th Floor, Rajiv Bhawan, Bhubaneswar.
6.	Place at which Quotation will be opened	Office of the Chief Engineer-cum-Project Director, Project Management Unit, 5 th Floor, Rajiv Bhawan, Bhubaneswar.
7.	Participants in the Quotation:	Electrical Contractors having valid HT/LT License with experience in erection of Electrical Sub-station, drawal of HT/LT Electric line and commissioning of Power Supply, who have registered under Orissa VAT Act / CST.
8.	Country of Origin	Goods supplied and related services commissioned under this contract shall have their origin from an eligible member country of ADB.
9.	Scope:	The specification of the materials involved in the above work covers the manufacture testing before despatch and delivery of the material at destination, at different LI points in Jajpur District shall be as given at Section-III.
10.	Standard:	The materials to be used in the work shall confirm to the latest publication of relevant Indian Standard Specifications / CPRI specification which should be mentioned in the quotation. In the absence of such specification, the specification provided by the Implementing Authority / DISTCO shall be final.
11.	Guarantee:	The work executed along with all materials used except transformer should be guaranteed for trouble free and satisfactory operation for 12 months. However, in case of 3 star rating transformers to be supplied, it should be minimum for 24 months, from the date of commissioning of the L.I. Project. Defects, if any noticed during the guarantee period due to faulty design, bad workmanship or poor quality of materials used, will have to be rectified / replaced by the Quotationer at free of cost. Such free rectification / replacement for defective work / loss or damage of material is to be made good by the Quotationer, immediately within seven days on receipt of information from the Implementing Authority or any other field Engineer of Implementing Authority or concerned PP Officials without waiting for settlement of claim if the Quotationer may think of having any.
12.	Rates:	The percentage rate should be quoted in the price schedule for execution of external electrification work at different LI projects in Badachana Block of Jajpur District situated in the State of Orissa inclusive of fright, packing, forwarding, loading, unloading, stacking, insurance charges and taxes and duties. (The list of LI projects is enclosed)

13.	Make & Brand:	The of the materials to be used should be of reputed make and brand and shall be mentioned in the offer.
14.	Quantity Restriction:	<p>I. Quantities indicated in the enclosed Bill of quantity are approximate and likely to increase or decrease not more than 25%.</p> <p>II. The quotation received for part quantity / part items will be treated as incomplete quotation and such quotation shall be rejected.</p>
15.	Validity:	The rates quoted by the Quotationer are to be valid for 180 days from the date of opening of the Quotation.
16.	Agreement:	The successful quotationer shall have to execute an agreement in the prescribed form with the Deputy Director, Dam Safety Support Services, Bhubaneswar within 7 days from the Date of issue of the Order after deposit of initial Security Deposit in full. Non execution of agreement in time shall lead to forfeiture of earnest money and cancellation of the order. Further, work must be started within 10 days from the date of issue of the order or else the order will be cancelled with forfeiture of EMD and imposition of penalty as deemed proper. The conditions of contract will also be applicable in addition to the conditions of contract mentioned in this document.
17.	Earnest Money Deposit:	The quotation document must be accompanied with earnest money of the amount as mentioned in the quotation notice to be deposited in shape of NSC / Postal Savings Bank Pass Book / Post office Term Deposit / Deposit Receipt of schedule Bank duly pledged in favour of Deputy Director, Dam Safety Support Services, Bhubaneswar in the absence of which the quotation will be rejected. EMD in any other form will not be accepted. Request for adjustment of outstanding deposit towards earnest money deposits will not be entertained. Earnest money will be refunded to the unsuccessful Quotationer only after the quotation is finalised and on receipt of written application from the Quotationer.
18.	VAT & PAN:	Attested copies of valid Orissa VAT Clearance Certificate in Form- 612 and PAN certificate should be enclosed with the Quotation without which the quotation is liable for rejection. The foreign Companies / bidder from outside State who intend to participate in the quotation and who is not registered under Section 99 of VAT act are allowed to participate in the quotation without having any VAT clearance certificate subject to condition that they should submit undertaking in form of affidavit indicating that they are not registered under the VAT act as they have not any business in the State of Odisha and they have no liability under the act as they have not started any business in the State of Orissa before award of contract. In absence of Odisha VAT clearance the outside state Quotationer has to submit Central Sales Tax clearance certificate, failing which the quotation will be liable for rejection.
19.	Fraud and Corruption:	<p>ADB's Anticorruption Policy requires borrowers (including beneficiaries of ADB - financed activity), as well as bidders, suppliers, and contractors under ADB - financed contracts, observe the highest standard of ethics during the procurement and execution of such contracts. In pursuance of this policy, the ADB:</p> <p>a) defines, for the purposes of this provision, the terms set forth below as follows :</p>

		<p>i. “Corrupt practice” means the offering, giving, receiving, or soliciting, directly or indirectly, anything of value to influence improperly the actions of another party;</p> <p>ii. “fraudulent practice” means any act or omission, including a misrepresentation, that knowingly or recklessly misleads, or attempts to mislead, a party to obtain a financial or other benefit or to avoid an obligation;</p> <p>iii. “coercive practice” means impairing or harming, or threatening to impair or harm, directly or indirectly, any party or the property of the party to influence improperly the actions of a party;</p> <p>iv. “collusive practice” means an arrangement between two or more parties designed to achieve an improper purpose, including influencing improperly the actions of another party.</p> <p>b) Will reject a proposal for award if it determines that the bidder recommended for award has, directly or through an agent, engaged in corrupt, fraudulent, collusive, or coercive practices in competing for the Contract: and.</p> <p>c) Will sanction a party or its successor, including declaring ineligible, either indefinitely or for a stated period of time, to participate in ADB-financed activities if it at any time determines that the firm has, directly or through an agent, engaged in corrupt, fraudulent, collusive, or coercive practices in competing for, or in executing, an ADB-financed contract.</p> <p>d) Will have the right to require that a provision be included in Bidding Documents and in contracts financed by an ADB Loan, requiring bidders, suppliers, contractors and consultants to permit the ADB to inspect their accounts and records and other documents relating to the Bid submission and contract performance and to have them audited by auditors appointed by the ADB.</p>
20.	Interpretation:	The decision of Chief Engineer–cum-P.D., PMU (OIIAWMIP),5 th Floor, Rajiv Bhawan, Bhubaneswar shall be final, binding and conclusive of all questions relating to the interpretation of the specification.
21.	Important Notes:	<p>i. Before submission of quotation, the Quotationer must be fully satisfied with the field condition and should gather all information and limitations so also official regulation at work site etc. Failure to comply the same will not relieve the Quotationer of his obligation and no matter whatsoever shall not be entertained on the ground of ignorance of site condition prevailing in the area.</p> <p>ii. It will be the responsibility of the Quotationer for transport of all the materials, tools and plants, equipments, machineries to work site as may be required for execution of work.</p> <p>iii. The Quotationer shall be responsible for self custody of materials at work site till handing over of the same to the Authorised Officers of DISTCOs after completion and energisation of the LI projects. In no case implementing authority will be responsible for loss or damage of any material / property at work site.</p>

		<p>iv. The materials at work site will be inspected by any Authorised Officers of Implementing Authority or jointly by the Officers of Implementing Authority and DISTCOs before or after utilisation of the same. The materials found not suitable during the inspection will be rejected and the Quotationer before energisation of the project should replace those materials.</p> <p>v. Unilateral stoppage of work by the Quotationer without prior approval of the Implementing Authority will be treated as breach of contract. Implementing Authority reserves the right to take any such action as deemed fit.</p> <p>vi. Neither the Quotationer or Implementing Authority shall be considered in default for delayed performance of its obligations, if such performance is prevented or delayed for hostilities, revolution, civil commotion, epidemic, accident, fire, cyclone, flood earthquake or because of any law and order proclamation, regulations or ordinance of the Government or because of any act of God, or for any cause beyond reasonable control. In such cases both the parties shall decide with each other regarding the future course of action to be taken on mutual agreement.</p> <p>vii. The Quotationer shall take every precaution not to damage or injure adjoining or other property of any person. He shall indemnify and indemnified the employee against all claims for injuries or damages to any person or any such property (including surface or land or crops at site) which may arise out of or in consequence of any negligence or default on the preventatives and against all claims, demands, proceedings, damages, costs, charges and expenses what so ever in respect of or in relation thereto. The Implementing Authority does not take any responsibility on this account.</p> <p>viii. Material at work site should be stacked / placed so as not to cause any inconvenience or danger to any person / public. The Quotationer should provide necessary fencing and light to protect the public from accident and shall be bound to bear expenses of defence of or any suite action or other proceedings of law that may be brought by any person for injury sustained due to neglect of above precaution.</p> <p>ix. The scope of work has been mentioned in the tender schedule. The Implementing Authority may alter the scope of work if the field conditions so warrants. The Quotationer should execute all such works at suitable rate approved by the Competent Authority, after getting written order from the respective Implementing Authority. The Implementing Authority may issue such written order in the site order book of the Quotationer.</p> <p>x. The Quotationer shall furnish a certificate along with the tender documents in sealed cover to the effect that he/she is not related to any officer in the rank of Assistant Engineer or above working in the Implementing Agency. If the declaration of the Quotationer awarded with the work subsequently proved to be false the contract will be rescinded. The earnest money and the total security will be forfeited and he /she shall be liable to make good the loss or damages resulting for such cancellation. The proforma for no relationship certificate is exhibited vide Annexure - K.</p>
--	--	--

		<p>xi. The Quotationer will sign and return the terms and conditions of the Quotation as token of acceptance. If the terms and conditions are not signed and returned, it will be presumed that the Quotationer is not agreeable to execute the work as per the stipulated terms and conditions and his offer will not be considered. Any conditional Quotation by the Quotationer will not be accepted.</p> <p>xii. Chief Engineer–cum-Project Director PMU, OIIAWMIP, Bhubaneswar can't issue C-Form to avail concession of VAT / CST.</p> <p>xiii. Eraser or alternation in the text of tender paper is not permitted. Eraser or / and alternation if any may either be disregarded or render whole Quotation void at the option of the authority competent to approve the Quotation. Correction / overwriting if any made by Quotationer must be authenticated by due initial by the authorised signatory. In case of any discrepancy in the item / items of the Quotation Call Notice / Quotation Schedule along with Terms and Condition of the Quotation, decision of the authority competent to receive the tender shall be final and binding.</p>
22.	Completion:	The successful Quotationer is required to complete the work of construction like erection of electrical Sub-station, drawal of HT / LT Electric line and Commissioning the Power Supply to the different L.I. projects inclusive of supply of all required materials within 30 days from the date of issue of the Work Order.
23.	Force majeure condition:	Force majeure is a common clause in contracts that essentially frees both parties from liability or obligation when an extraordinary event or circumstance beyond the control of the parties, such as a war, strike, riot, crime or an event described by the legal term "act of God" (such as flooding, earthquake or volcanic eruption) prevents one or both parties from fulfilling their obligations under the contract. However, force majeure is not intended to excuse negligence or other malfeasance of a party, as where non-performance is caused by the usual and natural consequences of external forces (for example, predicted rain stops an outdoor event), or where the intervening circumstances are specifically contemplated.
24.	Liasioning:	<p>The Quotationer after completion of the work shall arrange for inspection of the Electrical Inspector and obtain formal approval to charge the Electric Line and Sub-station.</p> <p>The Quotationer shall do with all liasioning with DISTCOs for connection, shutdown required for charging the Electrical Sub-Station and Electric line so constructed and also for handing over of the same to the authorised Officers of the DISTCOs after Completion of the work. Liasion of execution of Electrical Agreement by the Pani Panchayat with respective Executive Engineers of DISTCOs is also the responsibility of the Quotationer. The Implementing Authority will pay the required fees as per approved estimates given by the DISTCOs for the supervision purpose to the DISTCO authorities.</p> <p>The Implementing Authority shall write the letter required for above work to respective Executive Engineers of concerned DISTCO if the Quotationer needs so.</p>

25.	Past performance:	<p>The Quotationer is required to submit the List of works which are in hand at the time of submitting the Quotation indicating details of work.</p> <p>The Quotationer is required to submit the list of works (as at Annexure-A) which are in hand at the time of submitting the Quotation indicating (i) Name of work (ii) Name of particulars of organization / divisions where works are being executed (iii) Amount of work (iv) Position of works in progress (v) List of tools and plants available with the firm to take up the work (vi) Copies of article of Association Registration of the firm / Company along with copies of the signatories of the firm with power of attorney if any.</p>
26.	Qualification of the Quotationer	<p>The quotationer should have successfully executed similar nature of work of equal or more financial value in last five years.</p> <p>The bidders are to furnish list of works of similar nature of supply or contract made with other department/agencies and quantum of supply they have successfully completed. They should submit the copy of completion certificate along with the quotation in the prescribed format at annexure - A.</p>
27.	<p>Authority reserves the right to reject any or all Quotations or to accept any Quotation or to distribute the orders among Quotationers without assigning any reason thereof.</p>	
28.	<p>The rates should be quoted in the space given in the bill of quantities both in figures and words. In case of any discrepancy between these two, the words shall prevail.</p>	
29.	<p>The Quotationer should read carefully the Quotation schedule containing the terms and conditions, specifications in Appropriate sections and sign the Quotation schedule in each page and furnish along with the offer in original as a token of acceptance of the terms and conditions.</p>	

Client

Signature of the Bidder

SECTION - II

TERMS AND CONDITIONS

1. Security Deposit:

Additional amount over earlier Earnest Money is to be deposited to make initial security equal to 2% of the Value of Contract by the successful Quotationer in shape of NSC / Government of Orissa Loan Bond / Demand Draft from any Nationalised Bank duly pledged in favour of the Deputy Director, Dam safety and Support Services Bhubaneswar. The initial security shall have to be deposited before execution of agreement in PWD – F-2 Form by the Quotationer.

The total amount of Security Money deposited by the Quotationer shall be 7 % of the accepted Quotation amount. The balance security amount will be made up by deducting 5% of the amount of the gross payment of the Bill.

Additional Performance Security shall be furnished by the successful bidder at the time of drawal of agreement when the bid amount is less than the estimated cost by more than 10%, and within 15% in such event the successful bidder will deposit “additional performance security (APS)” to the extent of 1.5 times of the differential cost of the bid amount and 90% of the estimated cost. In other words additional performance security is to be deposited as per latest OPWD code. The additional performance security shall be furnished by the bidders in shape of NSC / Postal Savings Bank Pass Book / Post office Term Deposit / Deposit Receipt of schedule Bank duly pledged in favour of Deputy Director, Dam safety and Support Services Bhubaneswar payable at Bhubaneswar which will be over and above the initial Security Deposit. If the Quotationer fails to complete the work the amount so furnished as Additional Performance Security Deposit will also be forfeited in addition to other penal clauses as deemed fit.

2. Completion of Work:

The contractor / firm is required to complete the work assigned in the work order for different L.I. Projects of the district within 30 (thirty) days from the date of issue of such order.

3. Penalty & Cancellation: In every case where the execution Work is delayed partly or fully, the authority have the power to cancel the order without prejudice to the Authority's right to levy and recovery penalty by way of forfeiting the earnest money, security deposit and additional security deposit made by the Quotation for the particular work.

The work order for the particular work will be placed to the other participants, if the quotationer fails to execute the agreement within the stipulated time period or fails to take up / complete the work within the stipulated time period.

4. Extension of time: In case of force majeure condition if the execution of the work is delayed so as to necessitate an extension of time for execution, the Quotationer may be allowed time as per OPWD codal provision for which the Quotationer has to apply in writing, sufficiently ahead of the stipulated date of completion to the authority indicating sufficient reasons which hinder the completion of the work schedule and the authority may grant it in writing.

5. Test Certificate:

The Manufacturer's test certificate of materials to be used is to be delivered to the PP/ WUA at the time of starting of execution of work.

6. Inspection and Testing:

The Quotationer has to purchase the materials only from the Firms having valid VAT registration certificate / STCC clearance certificate or the approved Firms of the Electrical distribution companies. The authenticity of purchase along with warranty / Guarantee Certificate and test certificate of such major materials i.e., Transformers, PSC Poles, Electrical Conductors, Lightening Arresters, AB Switches, Distribution Boxes as may be required by the Implementing Authority and respective Executive Engineers of concerned DISTCOs shall have to be submitted by the Quotationer. In case of Transformer the Electrical Meter Relay (EMR) testing is mandatory, certifying that the Transformer is OK. The Quotationer should arrange for required letter of intimation to this effect to the MRT Division of concerned DISTCOs. The quotationer will deposit required amount of 6% supervision charges, Inspection fee & security deposit to DISTCOs authority which will be reimbursed.

7. Insurance:

The insurance of materials covered under this specification should be done at the Contractor's own risk. The responsibility of delivery of materials at destination in good condition rests with the Contractor. Any claim with the insurance company or Railway authorities, arising due to loss or damage in transit has to be settled by the Contractor.

8. Physical verification of materials:

Physical verification of materials (transformer, Energy Meter, HT/LT Line) should be done in between 10.00 AM to 5.00 PM on any working day after arrival of materials at site. Any shortage or damages should be verified in presence of the Quotationer's representative and six copies of damage or shortage certificate should be prepared and signatures be obtained from the representative of the Contractor and copies of such certificates should be sent to (i) the Contractor(ii) Deputy Director, Dam safety and Support Services Bhubaneswar (iii) CE-cum-PD, PMU, OIIAWMIP, 5th floor Rajeev Bhawan, Bhubaneswar (iv) concerned SIO Manager (v) concerned A.Es of OLIC deputed to the project (vi) concerned J.Es of OLIC deputed to the project . It is the responsibility of the Contractor to direct their representative accordingly.

9. Defective and non-standard material:

In the event of materials / equipments used by the contractor are found by the Consignee / Purchaser to be inferior than that described in the specification then the Contractor shall, on demand in writing forth with, remove the same at their own charge and cost and in the event of their neglecting to do so within such period as may be stated by the Consignee / Purchaser such rejected materials shall be removed at the Contractor's risk and the expenses incurred thereof shall be deducted from any due or which may become due to the Contractor or from the security deposit.

10. Price:

Prices are firm and fixed and not subject to any adjustment during the contract performance.

Payment:

Payment will be made by the Deputy Director, Dam Safety and Support Services. After completion of the work and inspection of the Electrical Inspector and after formal approval to charge the Electric Line and Sub-station constructed for energisation of LI project. The copy of the Inspection Report approved by the Electrical Inspector should be submitted to Implementing Authority along with the Bill. The fees payable for such, 6% supervision charges, security deposit & inspection fee will be reimbursed by the Implementing Agency on production of receipt by the Implementing Agency.

11. Settlement of Dispute:

The Implementing Agency and the Contractor shall make every effort to resolve amicably by direct informal negotiation, any disagreement or dispute arising between them under or in connection with the contract.

If the parties fail to resolve such a dispute or difference by mutual consultation within twenty eight (28) days from the commencement of such consultation, either party may require that the dispute be referred for resolution to the formal mechanism specified below.

12. Mechanism for Dispute Resolution:

Any dispute or difference arising out of this Contract or in connection therewith which cannot be amicably settled in accordance with Clause GC 8.2 shall be finally settled in accordance with the law of the purchaser's country. The arbitration shall take place in the location at Bhubaneswar. The resulting award shall be final and binding on the Parties and shall be in lieu of any other remedy.

13. Subletting of Contract:

Sub letting of the work is not permitted. In the event of the Quotationer sub-letting the contract they shall be considered to have committed breach of contract and their Security Deposit shall be forfeited and agreement may be rescinded.

SECTION – III

SCOPE OF WORK

1. General:

To work is to erect 11 K.V. H.T. line, L.T. line and commissioning of 11/0.4 KV stations ranging from 25 KVA to 100 KVA.

Besides this, in some projects erection of 11KV line D.P., Cut Point on 11 KV line, conversion of 2 phase 11 KV line to 3 phase 11 KV line, erection of guarding for road crossing / river crossing / power line crossing etc. are to be done.

For all the above works, the materials required, as mentioned in Annex. B to H are to be supplied by the contractors. The scope of works for each package has been mentioned in the tender call notice and respective price bid format.

2. Erection of 11 KV line:

In Annx. B, the list of materials to be used for 1 km of 11 KV line has been given. For different length of 11 KV line, as mentioned in tender notice, for different packages, materials to be used proportionately.

For all the packages, the size of conductor to be used is 55 mm² A.A.A.C. The length of span is to be 0.1 km, which may vary according to field situation as per the direction of Engineer-in-charge of OLIC & DISTCOs.

3. Erection of LT line:

In Annx. D and Annx. H, the materials to be used for 1 km of L.T. line with A.B. conductor of 34mm² and AAA conductor of 34mm² has been given respectively. For different length of L.T. line required for different packages as mentioned in tender call notice, materials to be used proportionately. The length of span of L.T. line with A.B. conductor is 0.03 km and that with AAA conductor is 0.05 km. The length may vary according to field situation as per the direction of Engineer-in-charge of OLIC & DISTCOs.

4. Sub-stations:

Materials to be used for 11/04 KV, 25 KVA, 63 KVA and 100 KVA S/S has been mentioned in Annx. C and in its parts. The scope of S/S for each package has been mentioned in the tender call notice.

The technical specifications of transformer, transformer oil, lightening arrester etc have mentioned in the part of Annx C. The Quotationer shall have to submit the test certificate of the transformer issued by the manufacturer.

5. Other works:

For other works i.e. Line D.P., Guarding, Cut point etc. respective annex. is to be followed.

SECTION – IV

Price Schedule for Execution of Power Supply Work in Rangidaspur-I RL Project under Badachana Block in Jajpur District

Scope of Work							
Sl. No.	Item	Unit	Quantity	Total Estimated Cost (Rs.)	% Excess (in Word)	% Less (in Word)	Equal to the above estimated cost.
1	a) Erection of 11 KV line 3 phase 3 wire with 9 Mtr. Long 300 Kg. PSC poles with 55mm ² AAA conductor and other required material as per the detail scope & specification including concreting of Poles and stay as per RE norms and as per direction of Engineer-in-Charge - 0.40 Km. b) Commissioning of double Pole mounted 11/0.4 KV 25 KVA sub-station with 3 star rated transformer using 9 Mtr. Long 300 Kg. PSC poles and other required materials as per the detail scope and specification including concreting of pole and stay as per direction of Engineer in-charge - 1 No. (All works are to be completed as per the estimate of CESU authority)	No.	1	404633.00			

(Rupees four lakh four thousand six hundred thirty-three only)

Full Signature of the Quotationer

CE-cum-PD, PMU, BBSR

Client

Signature of the Bidder

Date:-

Price Schedule for Execution of Power Supply Work in Jagannathpur RL Project under Badachana Block in Jajpur District

Scope of Work							
Sl. No.	Item	Unit	Quantity	Total Estimated Cost (Rs.)	% Excess (in Word)	% Less (in Word)	Equal to the above estimated cost.
1	a) Erection of 11 KV line 3 phase 3 wire with 9 Mtr. Long 300 Kg. PSC poles with 55mm ² AAA conductor and other required material as per the detail scope & specification including concreting of Poles and stay as per RE norms and as per direction of Engineer-in-Charge - 0.20 Km. b) Commissioning of double Pole mounted 11/0.4 KV 25 KVA sub-station with 3 star rated transformer using 9 Mtr. Long 300 Kg. PSC poles and other required materials as per the detail scope and specification including concreting of pole and stay as per direction of Engineer in-charge - 1 No. (All works are to be completed as per the estimate of CESU authority)	No.	1	347003.00			

(Rupees three lakh forty-seven thousand three only)

Full Signature of the Quotationer
Date:-

CE-cum-PD, PMU, BBSR

Client

Signature of the Bidder

Price Schedule for Execution of Power Supply Work in Sanabandala RL Project under Badachana Block in Jajpur District

Scope of Work							
Sl. No.	Item	Unit	Quantity	Total Estimated Cost (Rs.)	% Excess (in Word)	% Less (in Word)	Equal to the above estimated cost.
1	<p>a) Erection of 11 KV line 3 phase 3 wire with 9 Mtr. Long 300 Kg. PSC poles with 55mm² AAA conductor and other required material as per the detail scope & specification including concreting of Poles and stay as per RE norms and as per direction of Engineer-in-Charge - 0.50 Km.</p> <p>b) Commissioning of double Pole mounted 11/0.4 KV 25 KVA sub-station with 3 star rated transformer using 9 Mtr. Long 300 Kg. PSC poles and other required materials as per the detail scope and specification including concreting of pole and stay as per direction of Engineer in-charge - 1 No.</p> <p>(All works are to be completed as per the estimate of CESU authority)</p>	No.	1	449516.00			

(Rupees four lakh forty-nine thousand five hundred sixteen only)

Full Signature of the Quotationer
Date:-

CE-cum-PD, PMU, BBSR

Client

Signature of the Bidder

Price Schedule for Execution of Power Supply Work in Rambhadeipur-I RL Project under Badachana Block in Jajpur District

Scope of Work							
Sl. No.	Item	Unit	Quantity	Total Estimated Cost (Rs.)	% Excess (in Word)	% Less (in Word)	Equal to the above estimated cost.
1	<p>a) Erection of 11 KV line 3 phase 3 wire with 9 Mtr. Long 300 Kg. PSC poles with 55mm² AAA conductor and other required material as per the detail scope & specification including concreting of Poles and stay as per RE norms and as per direction of Engineer-in-Charge - 0.20 Km.</p> <p>b) Commissioning of double Pole mounted 11/0.4 KV 25 KVA sub-station with 3 star rated transformer using 9 Mtr. Long 300 Kg. PSC poles and other required materials as per the detail scope and specification including concreting of pole and stay as per direction of Engineer in-charge - 1 No.</p> <p>(All works are to be completed as per the estimate of CESU authority)</p>	No.	1	347003.00			

(Rupees three lakh forty-seven thousand three only)

Full Signature of the Quotationer
Date:-

CE-cum-PD, PMU, BBSR

Client

Signature of the Bidder

Price Schedule for Execution of Power Supply Work in Rambhadeipur-II RL Project under Badachana Block in Jajpur District

Scope of Work							
Sl. No.	Item	Unit	Quantity	Total Estimated Cost (Rs.)	% Excess (in Word)	% Less (in Word)	Equal to the above estimated cost.
1	<p>a) Erection of 11 KV line 3 phase 3 wire with 9 Mtr. Long 300 Kg. PSC poles with 55mm² AAA conductor and other required material as per the detail scope & specification including concreting of Poles and stay as per RE norms and as per direction of Engineer-in-Charge - 0.20 Km.</p> <p>b) Commissioning of double Pole mounted 11/0.4 KV 25 KVA sub-station with 3 star rated transformer using 9 Mtr. Long 300 Kg. PSC poles and other required materials as per the detail scope and specification including concreting of pole and stay as per direction of Engineer in-charge - 1 No.</p> <p>(All works are to be completed as per the estimate of CESU authority)</p>	No.	1	347003.00			

(Rupees three lakh forty-seven thousand three only)

Full Signature of the Quotationer
Date:-

CE-cum-PD, PMU, BBSR

Client

Signature of the Bidder

Price Schedule for Execution of Power Supply Work in Bhubanpur-II RL Project under Badachana Block in Jajpur District

Scope of Work							
Sl. No.	Item	Unit	Quantity	Total Estimated Cost (Rs.)	% Excess (in Word)	% Less (in Word)	Equal to the above estimated cost.
1	<p>a) Erection of 11 KV line 3 phase 3 wire with 9 Mtr. Long 300 Kg. PSC poles with 55mm² AAA conductor and other required material as per the detail scope & specification including concreting of Poles and stay as per RE norms and as per direction of Engineer-in-Charge - 0.30 Km.</p> <p>b) Commissioning of double Pole mounted 11/0.4 KV 25 KVA sub-station with 3 star rated transformer using 9 Mtr. Long 300 Kg. PSC poles and other required materials as per the detail scope and specification including concreting of pole and stay as per direction of Engineer in-charge - 1 No.</p> <p>(All works are to be completed as per the estimate of CESU authority)</p>	No.	1	377304.00			

(Rupees three lakh seventy-seven thousand three hundred four only)

Full Signature of the Quotationer
Date:-

CE-cum-PD, PMU, BBSR

Client

Signature of the Bidder

LIST OF THE WORKS EXECUTED BY THE QUOTATIONER

Sl. No.	Client	Brief description of the work	Contract Amount (in lakh)	Date of Starting	Date of Completion

N. B.

- 1) The quotationer need to have to submit the xerox copies of work order and completion certificate (s).
- 2) If work is yet to be completed, pleased write “continuing”.

Client

Signature of the Bidder

TECHNICAL PARTICULARS

Annexure – B

MATERIAL TO BE USED FOR 1 KM OF 3 PHASES 11 KV LINE

Sl. No.	Description of materials	Rec. Sp.	Unit	Qty. to be used	Reference
01	11 KV X Arm 100*50*5 Channel	A-6	No.	14	Drg. I&II
02	Top Bracket			14	
03	11 KV Pin Insulator	3/1971	No.	29	DRG IX
04	11 KV G.I. Pin	3/1971	No.	50	DRG IX
05	11 KV Disc. Insulator (T&C Type)	3/1971	No.	40	
06	11 KV Hard wire fitting (T&C Type)	3/1971	No.	20	
07	HT Stay set complete	G-2	No.	5	Drg-III (As per the field requirement)
08	Stay Clamp	-	Pair	5	
09	Back clamp for X arm	X-2	No.	14	Drg. – IV
10	Earthing (Coil Type) for support	J-1	No.	17	Drg-VIII
11	PSC Pole 300 kg, 9mts long for cut point.	-	No.	17	
12	Anti climbing device made of GI barbed wire, clamping arrangement etc. (2 kg. Per support)		Kg.	33	Drg. 0V
13	55Sqmm AAAC	-	Km.	3.09	
14	7/10 SWG Stay wire	-	No.	50	
15	Stay Insulator	-	No.	5	
16	Concrete material for stay anchor plate	-	No.	5	
17	Supply of guarding materials for road crossing.	-	No.		As required
18	100X50X60mm channel for straight cross arm 1.2mts.etc.	-	Kg.	147	
19	G.I. Nuts, Bolts, Washers etc.	-	Kg.	51	As required

N.B.

1. The length of one span of 11KV line is 0.1km, which may vary according to field situation as per the direction of Engineer-in-charge.
2. The List of materials given above is requirement for 1Km 11 KV line. For different length, materials to be used proportionately.
3. All the cross arm & top bracket are to be painted with anti-corrosion paints and each support is to be provided with anti climbing device for a minimum length of 3 feet.
4. PSC pole used in above work should be written by paint “**ADB work**”.

Annexure – C (Part – i)

MATERIALS TO BE USED FOR 25 KVA 11 / 0.4 KV SUB STATION

SI No.	Description of materials	Rec. Spn. Std.	Unit	Qty.	Reference
1	9 mtr. Long PSC Pole 300kg	3F-3	No/Kg	02	
2	Pressure channel 100*50*6mm MS channel 2.8Mtr long		Kg.	51.52	
3	Transformer mounting channel 100x50x6mm 2.8 mtr. Long	F-3	No/Kg	51.52	
4	11 KV A.B. Switch & HG fuse, Mounting channel 75*40*6 each 2.8 Mtr.	F-9	Kg.	76.16	
5	Transformer belting (50x50x 6mm) M.S . Angele 2.8 mtr long .	F-3	Kg.	31.5	
6	Angle for mounting LT distribution Box 50x50x6mm, 2mt long	-	Kg	22.5	
7	11 KV AB Switch 3 pole		No.	1	
8	11 KV HG fuse 3 pole		No.	1	
9	11 KV L.A.	F-9	No	3	Annx.C, Part-5
10	HT Stay set complete with stay wire	G-2	No.	4	
11	HT stay Insulator (T&C)	-	No.	4	
12	HT stay Clamp (T&C)		No.	4	
13	7/10 SWG stay wire		Kg.	40	
14	G.I. Pipe earthing 40mm dia , 2.5mtr long	J-2	No	3	DRG –VI
15	25x5mm GI flat for natural & all equipment earthing		Kg.	35	
16	55sq mm AAAC		Kg.	0.04	
17	Red oxide paint		Ltr.	3	
18	All paint		Ltr.	4	
19	Black paint		Ltr.	0.5	
20	MS nut, bolt & washer		Kg.	36	
21	25 KVA, 11/0.4KV 3 star rated transformer		No.	1	
22	L.T Distribution Box including kit fuse (200 Amp)	-	No	1	2'x1.5'x10" Size
23	L.T. PVC cable 3 ½ core For 25 KVA – 35 Sqmm.	-	Mtr.	15	
24	Sundries for survey, PVC tape, Ampire Tape, Danger Board, small size nut & blot, cable socket etc.		Ls.	1	

- NB: 1. The masonry work for earth pit is to be done with 5" brick wall of length 2', width 2', and depth 3'.
Depth under G.L. – 1.5', Above G.L. – 1.5'
2. All the channels are to be painted with anti corrosion paint.
3. The Poles are to be covered with anti-climbing device for a minimum length of 6 feet.

STANDARD TECHNICAL PARTICULARS OF TRANSFORMER

Annexure – C (Part – ii)

(Transformer of the substation to be commissioned)

1	Specification	REC 2/ 1971						
2	Service	OUT DOOR						
3	KV A Rating		63 KVA TT.	100 KVA TT.		250 KVA		
	a) H.V. Winding	KVA	25	63	100	250		
	b) 1. V. Winding	KVA	25	63	100	250		
4	a) H. V. Winding	KV	11	11	11	11		
	b) L.V. Winding	KV	0.433	0.433	0.433			
5	Rated frequency	Hz	50	50	50			
6	Number of phases		3	3	3	3		
7	Connections							
	a) H. V. Winding		Delta	Delta	Delta			
	b) 1.V. Winding		Star	Star	Star			
8	Connection symbol							
9	Tapping			I				
	a) Range	+2.5% to -15% in steps of Transformer		2.5% each (off load)				
	b) Number of steps for high voltage variation/for intermediate voltage variation/ for low voltage variation			8 nos. H.V. Variation				
10	Reference ambient temperature							
	a) Maximum ambient air / temperature.		45	45	45	45		
	b) Maximum daily average oC		35	35	35	35		
	c) Maximum yearly average air temperature oC		32	32	32	32		
	d) Minimum ambient air temperature oC		0	0	0	0		
	e) Maximum cooling water temperature oC		NA	NA	NA	NA		
11	Type of cooling	ONAN						
12	Temperature rise							
	a) Temperature of oil oC b) Winding oC							
13	Total loss at rated voltage & rated frequency	W		1415	2020	4320		
	Component losses							
14	a) No load loss at rated voltage			180	260	620		
	b) Load loss at rated current at 75 degree C.	W	1235	1760	3700			
15								
	a) HV - LV	%			4.5	4.5	5	
16	Reactance at rated current & rated frequency			%	3.57	4.05	4.14	4.78

17	No load current at rated voltage & rated frequency and also at 50% voltage 75% Voltage & 112 Y2 % voltage and rated frequency		Within 2% of full load current at rated voltage / current attracted voltage / rated Frequency.			
			50% 75% 112.5%	0.7% 1.2% 2.5%	In all Cases.	
18	Insulation level	Sec. IS-2026 (Pt. III /77)				
	a) Separate source power frequency voltage withstands.					
	i) H. V. Winding	KV rms.	28	28"	28	28
	ii)L.V. winding	KV rms.	3	3	3	3
	b) Induced over voltage withstand					
	i) H. V. Winding	KV rms.	22	22	22	22
	ii)L.V. Winding	KV rms.	0.866	0.866	0.866	0.866
	c) Full wave lightning impulse with stand voltages with time yrs. Peak voltage Characteristic curves.					
	i)H.V. Winding	KV peak	75	75	75	75
	ii) L.V. Winding	KV Peak	.-	-	-	-
	d) P. I. Value	More than	1.5	1.5	1.5	1.5
	19	Efficiencies at 75 degree at unity power factor				
a) at full load		%	96.96	97.80	98.02	98.30
b) at % full load		%	97.48	98.18	98.36	98.56
c) at Y2 fun load		%	97.88	98.47	98.62	98.78
d) at 120% full load		%	96.42	97.39	97.65	97.99
20	Regulation at full load at 75 degree C.					
	a) at unit power factor	%	2.80	1.96	1.84	1.59
	b) at 0.8 power factor loading	%	4.35	4.05	3.91	4.16
21	Equipment for ONAN cooling					
	a) State					
	i) Radiators on main tank	-	Yes	Yes	Yes	Yes
	ii) Separate cooler tank	-	No	No	No	No
	b) State ONAN rating in case of mixed cooling	-	-	-	-	-
22	Number of coolers or cooler banks per transformer (type or radiators provided and surface area)				Not applicable	I
23	Rating of each cooler or cooler tank				Not applicable	
24	Terminal arrangement					
	a) High voltage	Out door type porcelain oil type bushings as per 18-3347 & 18-2099				
	b) Neutral	Out doortype porcelain oil type bushings as per 18-3347 & 18-2099				
	c) Low voltage	Out door type porcelain oil type bushings as per 18-3347 & 18-2099				
	d) Intennediate voltage	out door type porcelain oil type bushings as per 18-3347 & 18-2099				
25	Approximate masses					
	a) Core	Kg.	70	130	170	580
	b) Winding	Kg.	31	53	67	580

	c) Tank, fittings and accessories. (Name of accessories to be mentioned)		75 Kg.	115 Kg.	138 Kg.	370 Kg.
	d) Oil	Kg.	52	115	125	350
	e) Total mass	Kg.	240	440	500	1300
26	Approximate quantity of oil required for first filling.		60 Ltrs.	135 Ltrs.	145 Ltrs.	400 Ltrs.
27	Approximate over all dimension					
	a) Length	Mm.	780	900	960	1360
	b) Breadth	Mm.	740	875	730	
	c) Thickness of main tank covers plate side and bottom plate.		5/3/5 Mm	5/3/5 Mm	5/3/5 Mm	5/3/5 Mm
	e) Tank inside and outside dimension (Length/Breadth/Height)	L	665/671.3	760/766.3	820/826.3	930/936.3
		B	265/271.3	295/301.3	315/321.3	360/366.3
		H	650/660	675/685	715/725	1070/1080
28	Untanking height	Mm	1800	2500	2600	3000
29	i) Efficiency at 75°C and 0.8 PF lagging ..					
	At full load	%	96.22	97.27	97.54	97.89
	At % full load	%	96.87	97.74	97.96	98.23
	At % full load	%	97.36	98.10	98.28	98.48
	Over loading capacity and efficiency		As per 18-6600			
	ii) Load at which maximum efficiency		38.20%	38.20%	38.40%	40.90%
	iii) Maximum efficiency		97.95%	98.53%	98.67%	98.80%
	iv) Impulse level with 1/50 M. 8. Wave.					
	High Voltage	KV	75	75	75	75
	Low Voltage	KV	-	-	-	-
	v) No load loss at 112-V2% rated voltage & rated frequency.		0.15 KW	0.27 KW	0.39 KW	0.90 KW
	vi) No load current at 112 V2% rated voltage & rated frequency		5%	5%	5%	5%
	vii) Type of winding					
	High Voltage	-	Circular concentric			
	Low voltage	-	Helical			
	No. of turns of H.V.	-	6864	4224	3344	2288
	No. of Turns of L.V.	-	156	96	76	42
	viii) Insulation materials					
	Turn insulation high voltage		DPC			
	Turn insulation low voltage		DPC			
	Insulation core to low voltage		Press pan and oil duct.			
	Insulation high voltage to low		Con:ugated cylinder and oil duct.			
	Insulation and coil (top/bottom) to yoke.		Angle sharp and ring and pressboard.			
	ix) Clearance					
	Minimum clearance between phases					
	a) In oil	Mm	10	10	10	10
	b) Out of oil	Mm	255	255	255	255
	Maximum clearance high voltage to tank in oil		25 Mm	25	25	25

	Minimum clearance high voltage to earth in oil	20Mm	20	20	20
	x) Minimum clearance height for lifting core and windings from tank	1800 Mm	2500 Mm	2600 Mm	3000 Mm
30	i) Core materials used and grade	CRGO	GRADE	M4	
	ii) Loss watts jkg of core materials corresponding to desired flux density.	1.25 W jkg.	1.25 Wjkg.	1.25 Wjkg.	1.25 Wjkg.
31	Resistance of winding at ambient temperature per phase in Ohms.				
	a) H. V.	Ohms.	225	63	36
	b) L. V.	Ohms	77	22	12
32	Oil date				
	1) Quantity for first filling	Ltrs.	60	135	145
	2) Grade of oil used		Neptha base, EHV grade		
	3) Maker's name		Madras Petro Chemicals or any reputed company.		
	4) B.D.V. at the time of filling.	KV	Above 60KV in 2.5 mm gap.		
33	Make of breather & type with capacity of silica gel filled in grams.	Gms	Make-AtvusjSuvida make transparent silica gel		
			60 gms.	60 gms.	250 gms
34	Inter layer insulation provided in design for				
	i) Top & bottom layer		..	Press pan.	
	2) In between all layer..s.			Exoxy dotted manila paper	
	3) Details of insulation		Winding is uniformly insulated for better impulse level.		
	4) Whether wedges are provided at 50% turns of the coil				Yes.
35	Insulation materials				
	a) For conductor HV		DPC		
	LV		DPC		
	b) For core		Carlite		
36	Particulars of bushings				
	1) Maker's name		M/s. India Potteries, Calcutta, or any reputed Company.		
	2) Type	S-3347 jIS-1180	As per IS-334 7		
	3) Rating as per IS		As per IS-2088		
	4) Dry flash over voltage at 50% C/S KV		As per IS-7421		
37	!.R. value at 30°C.				
	HVjE		More than 500 mega Ohms		
	LVjE		-do-		
	HVjLV		-do-		
38	P.!. Value in 10 minutesj 1 minutes measurement				
	HVjE		More than 1.5		
	LVjE		-do-		
	HV jLV		-do-		

Annexure -'C' (Part – iii)

THE BUSING SHALL CONFORM IS-2099 /1973 SPECIFICATION FOR HIGH VOLTAGE PORCELAIN BUSHINGS

The bushing rods and nuts shall be made of brass. The dia dimensions of bushing of the following voltage classes shall conform to Indian Standards mentioned against them.

Voltage class	For porcelain parts	For metal parts
Up to 1.1 KV bushing	IS-3347 (part-I)	IS-3347 (Part)
	(Section-I) 1965	(Section-I) 1967
12 KV bushing	IS-3347 (part-III)	IS-3347 (part-III)
	(Section-I) 1972	(Section-H) 1967

1. Routing Test

All the transformers shall be subjected to routine test at the manufacturer work as per IS-2026/1977 or its latest amendment if any.

The following tests are to be carried out:

- a) Measurement of winding resistance: (For 250 KVA on all taps)
- b) Ratio, polarity and phase relationship:
- c) Measurement of impedance voltage:(On all taps in 250 KVA)
- d) Measurement of load loss and
Measurement of natural unbalance current: (For 250 KVA on all taps)
- e) No load loss and current at 100% of no. load voltage.
- f) Insulation resistance, in 1 minute & 10 minutes duration by 2.5 KV motorized Megger.
- g) Induced over voltage withstand test.
- h) Separate sources voltage withstanding test and measurement of leakage current to earth.
- i) Magnetic balance test.
- j) Air Pressure and oil leakage test of transformers.
- k) Vector group test.
- l) Measurement of dimensions.
- m) Measurement of P.I. Value in 10 Minute/1 minute durations by 2.5 KV.
- n) Oil BDV test.

2. Temperature rise test.

TRANSFORMER OIL CHARACTERISTICS

1	Appearance	The oil shall be clear and transparent and free from suspended matter or sediment.
2	Density at 29.500(max)	0.89 GJcm ³
3	Kinematics viscosity at 27°C (max)	27 Cst.
4	Interfacial tension at 27°C (minimum)	0.04 JNjM
5	Flash point, pen sky marten (closed) IIIIII1ID.um	140°C
6	Pour point (max)	6°C
7	Neutralization value (total acidity) Maximum	0.03 mg koh jG
8	Corrosive sulphur	No corrosive
9	Electric strength (break down voltage) Minimum	a) New untreated oil - 30 KV (rms) b) Mter f1literation-60 KV (rms)
10	Dielectric dissipation factor (tan delta) at 90°C(maximum)	0.002
11	Specific resistance (resistively)	
	a) At 90°C (minimum)	12 35 x 10 Ohm -cm.
	b) At 27° (minimum)	12 1500 x 10 Ohm -cm.
12	Oxidation stability	
	a) Neutralization value	0.40 mg. KOHjg.
	b) Total sludge after oxidation Maxunum	0.10 percent by weight.
13	Presence of oxidation in hibitor	The oil shall not contain anti-oxidant additives.
14	Water content (maximum)	50 Ppm.
15	The oil should have the following characteristics after under going oxidative aging test with copper catalyst as per ASTM DI-934	
	a) Resistively at 90°C (minimum)	12 0.2 x 10 Ohm -cm.
	b) Resistively at 27° (minimum)	12 2.5 x 10 Ohm -cm.
	c) Tan delta at 90°C (maximum)	0.20
	d) Total acidity (maximum)	0.05 mgjkohj g.
	e) Total sludge (maximum)	0.05% by weight.

Annexure –‘C’ (Part – v)

TECHNICAL PARTICULARS OF LIGHTENING ARRESTER

(REC SPECIFICATION NO. F-9)

1	Type	Metal oxide gapless distribution type.
2	No. of units	1 (one)
3	Rated voltage (KV rlls)	12
4	Nominal discharge current (KA)	5
5	Reference current (m.a)	1
6	Reference voltage (KV rlls)	Greater than the rated voltage.
7	Current at MOOV	
	i) Resistive current IR	0.8 m A
	ii) Capacitive current IC	1.2 m A
8	Maximum residual voltage for discharge current of 8/20 micro second wave at	
	i) 0.5 time the nominal discharge current	KV (P) 40
	ii) 1 time the nominal discharge current	KV (P) 42
	iii) 2 times the nominal discharge current	KV (P) 48
9	Maximum continuous operative voltage (KV rms)	12
10	High current impulse withstand (KA)	65
11	Insulation withstand	
	i) Lightning impulse (KA peak)	75
	ii) P.F. (dry/wet) (KV rms)	35
12	Temporary over voltage withstand capability (KV peak)	
	i) At 0.1 second	19
	ii) At 1 Second	17.5
	iii) At 10 Second	15.5
	iv) At 100 Second	14
13	Maximum ratio interference voltage	250 microvolts
14	Maximum step current impulse residual voltage at nominal discharge current of 1 micro second front time (KV peak)	48
15	Height of complete unit (mm)	380
16	Maximum recommended spacing between arrester center to center (mm)	300
17	Clearance required from ground equipment to various heights of arrester unit (mm)	285
18	Earthing arrangement	To be provided
19	Mounting flange dimensional details (mm)	Mounting clamps to be provided
20	Total creep-age distance (mm)	300
21	Weight of complete unit (Kg)	4.4

Annexure –‘D’**MATERIALS TO BE USED FOR 1 KM L.T. LINE OF 3 PHASES WITH A.B. CONDUCTOR**

Sl. No.	Description of Material	REC specification	Units	Qty.	Reference
1	Suspension fitting + façade hook + pole clamp pair + suspension clamp	-	No.	38	
2	Stay set complete with stay wire	-	No.	08	7/12 SWG stay wire – 42 kg
3	Nuts & Bolts (Assorted size)	-	Kg.	15	
4	Stay Clamp	-	Pair	08	
5	L.T. stay insulator	-	No.	08	
6	Service connection distribution box	-	No.	20	
7	Concerting of Stay	-	No.	08	
8	Coil earthing	J – 1	No.	33	With No.8 G.I. wire – 17 kg
9	Piercing conductor	-	No.	20	
10	PSC Pole, 200 kg, 8mt long	-	No.	33	
11	AB Conductor 50 Sqmm	-	Km.	1.06	

N.B.: 1. Length of the span is 0.03 km. the length may vary according to field situation as per the direction of Engineer-in-Charge of OLIC.

2. The list of materials given above is the requirement for 1 km LT line, for different length, materials to be used proportionately.

Client**Signature of the Bidder**

Annexure –‘E’**MATERIALS TO BE USED FOR ONE No. CUT POINT FOR 3 PHASE 11 KV OVERLOAD LINE**

Sl. No.	Description of Materials	Unit	Qty.	Remarks
1	PSC Pole, 9mt. long, 300 kg	No.	1	
2	75x40mm channel for straight Cross arm, 1.2mt. long	No./KG	4/32.64	
3	Disc Insulator (T&C)	No.	6	
4	Hardware fitting for Disc Insulator (T&C)	No.	6	
5	11 KV Pin Insulator	No.	1	
6	HT Stay set complete	No.	3	
7	Stay Insulator	No.	3	
8	7/10 SWG Stay wire	Kg	30	
9	Nuts, Bolts, Washers	Kg	2	
10	Concrete Materials for stay anchor plate	No.	3	
11	Padding & Concrete Materials for support	No.	1	
12	Coil Earthing for support	No.	1	
13	11 KV G.I. Pin	No.	1	
14	Stay Clamp	Pair	3	

Annexure –‘F’

**MATERIALS TO BE USED FOR ONE NO. OF GUARDING TO BE ERECTED IN 11 KV
OVERLOAD LINE FOR ROAD, POWER LINE, TELEPHONE LINE CROSSING ETC**

Sl. No.	Description of Materials	Unit	Qty.	Remarks
1	75X40 mm channel, 1.5 mt. Long	No/Kg	2/20.4	
2	Back clamp for channel	No.	2	
3	Eye hook	No.	10	
4	SWG 8, G.I. Wire	Kg.	20	
5	Nuts, Bolts, Washer	Kg.	1	

Client

Signature of the Bidder

Annexure –‘G’**Materials required for Erection of 1 k.m of 3 phase 4 wire L.T. line with 8M X 200 KG PSC Pole 34 sq. mm AAAC (50 mtr. Span)**

Sl. No.	Description of materials	Unit.	Qty.
1	LT 3 Ph – 4 Wire Cross Arm	No.	23
2	LT. Pin Insulator	No.	54
3	LT GI Pin	No.	54
4	LT Shackle Insulator	No.	12
5	LT Straps with nuts & bolts	Set	16
6	CI Knob	No.	22
7	Stay Set Complete	No.	6
8	7/12 SWG Stay wire	Kg.	42
9	Back Clamp for cross Arm	No.	19
10	Stay Clamp	Pair	6
11	LT Stay Insulator	No.	6
12	No. 8 G.I. wire for earthing	Kg.	10
13	4 wire spacers	No.	20
14	Supports PSC Pole (8m. Long)	No.	20
15	Conductor 34 mm sq. AB Cable	Km.	1.05

Client**Signature of the Bidder**

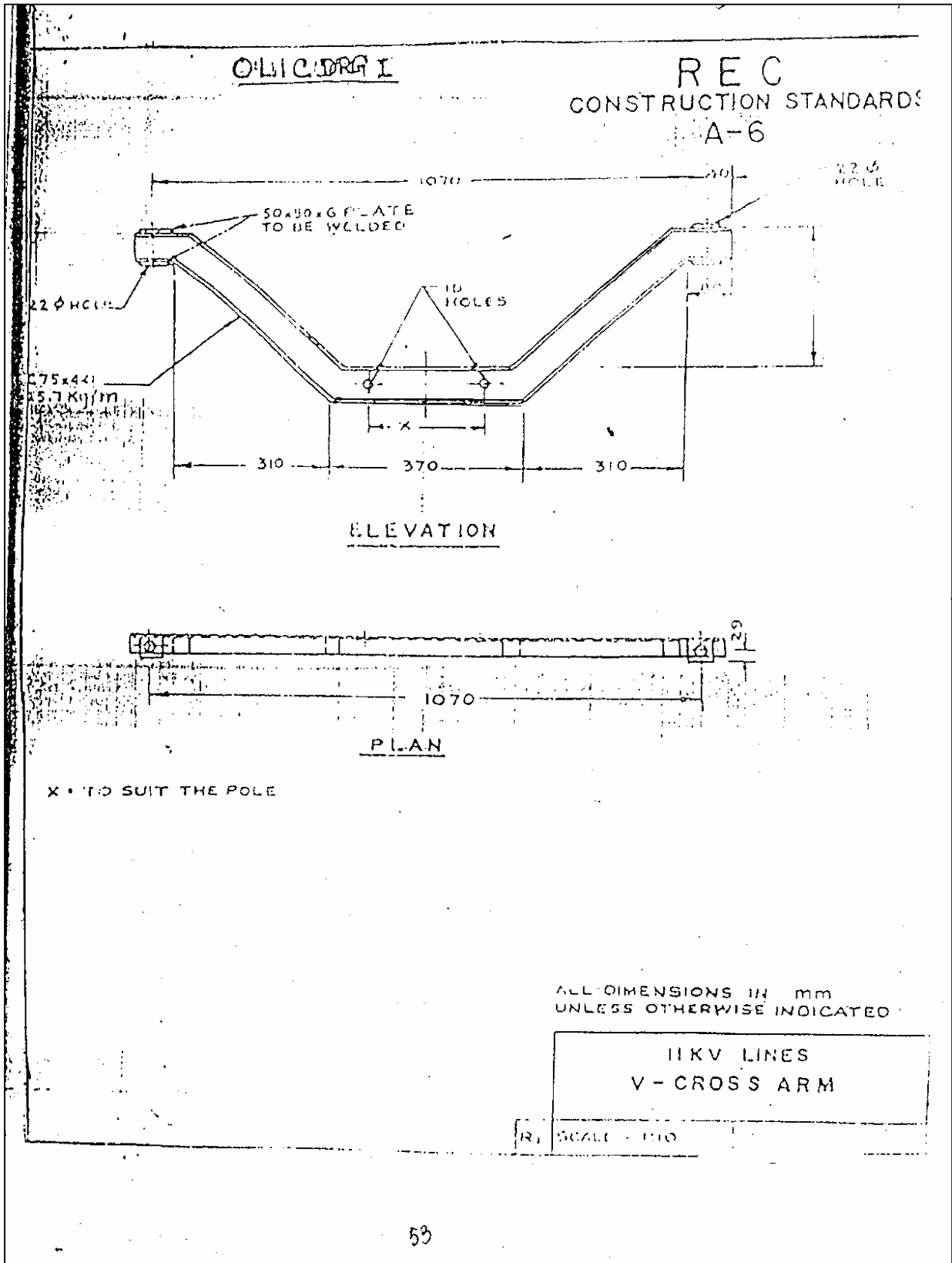

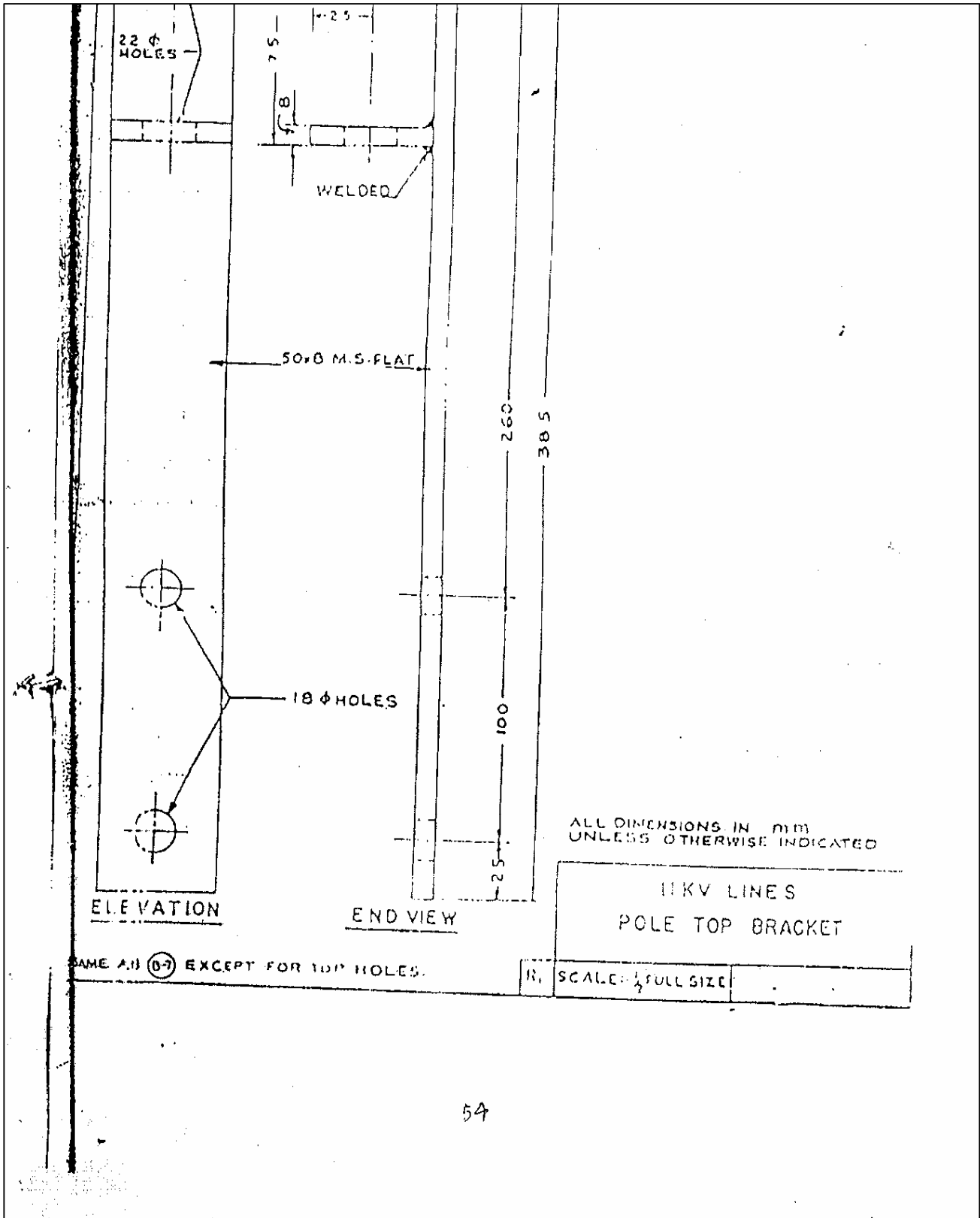

54

Client

Signature of the Bidder

OLIC DRG- ∇ REC
 CONSTRUCTION STANDARDS
 C-2

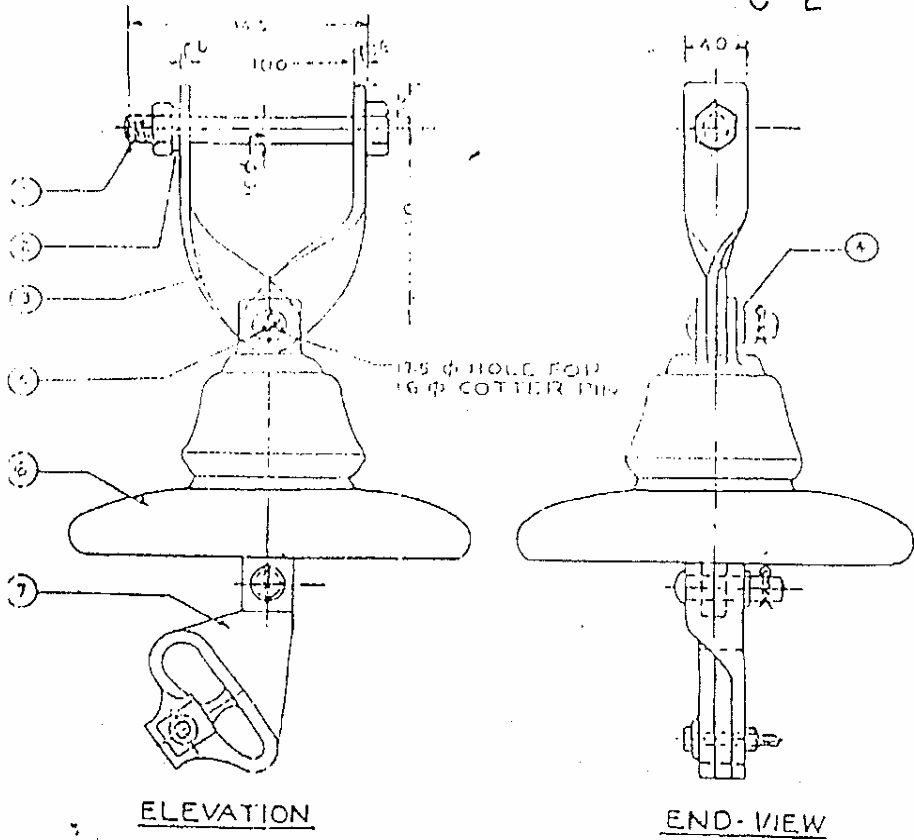

ELEVATION

END-VIEW

BILL OF MATERIAL	
1	BOLT-NUT- 16 ϕ x 14.5
2	SPRING WASHER
3	CROSS-ARM STRAPS
4	WASHER
5	COTTER PIN
6	DISC INSULATOR
7	CLEVIS ENDED CLAMP WITH ALUMINIUM LINER

ALL DIMENSIONS IN MM UNLESS OTHERWISE INDICATED

11KV INSULATORS & FITTINGS
 CLEVIS AND TONGUE TYPE STRAIN
 INSULATOR SET

SCALE: 1:1 DEPT

OLIC DRG VI

REC
CONSTRUCTION STANDARDS
J-2

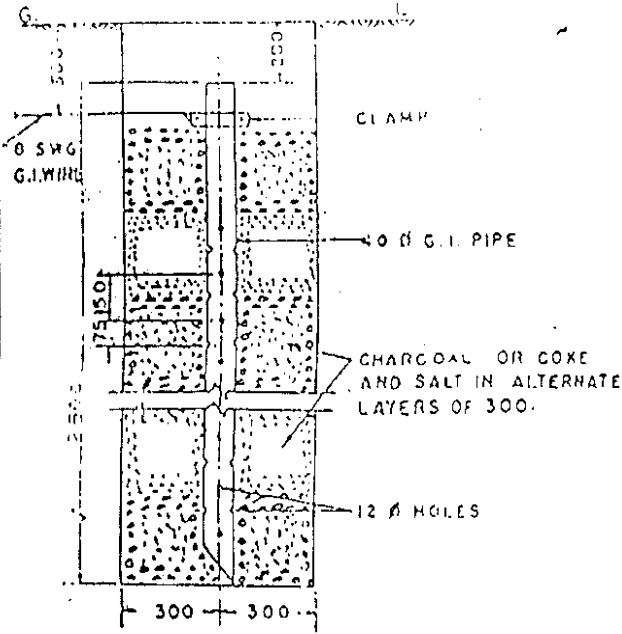

EARTHING FOR HARD, STIFF
OR MEDIUM CLAY

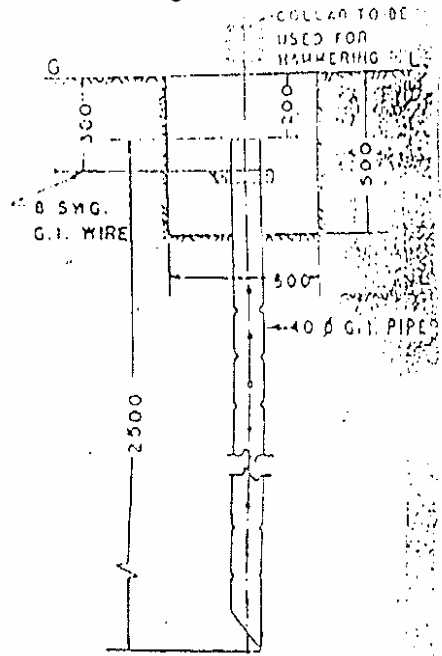

EARTHING FOR ORDINARY SOIL
WHERE PIPE COULD BE HAMMERED

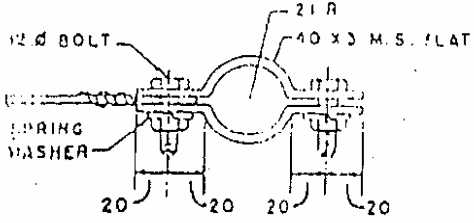

TYPICAL DETAIL OF CLAMP
FOR PIPE EARTH

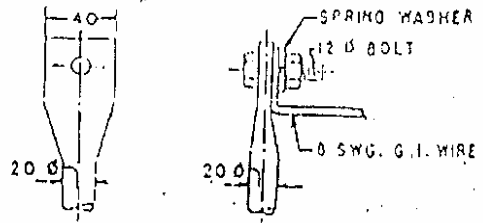

TYPICAL DETAIL OF CONNECTION
FOR ROD EARTH

NOTES:-

- 1 ALTERNATIVELY 20 Ø G.I. ROD MAY BE USED INSTEAD OF PIPE
- 2 WATER TO BE POURD INTO CLAMP TO KEEP THE SOIL SURROUNDING THE EARTH PIPE / ROD MOIST
- 3 FOR COIL EARTHING REFER CONSTRUCTION STD 50 J4

ALL DIMENSIONS IN MM

PIPE / ROD EARTHING	
SCALE - H.T. 5	2000

147

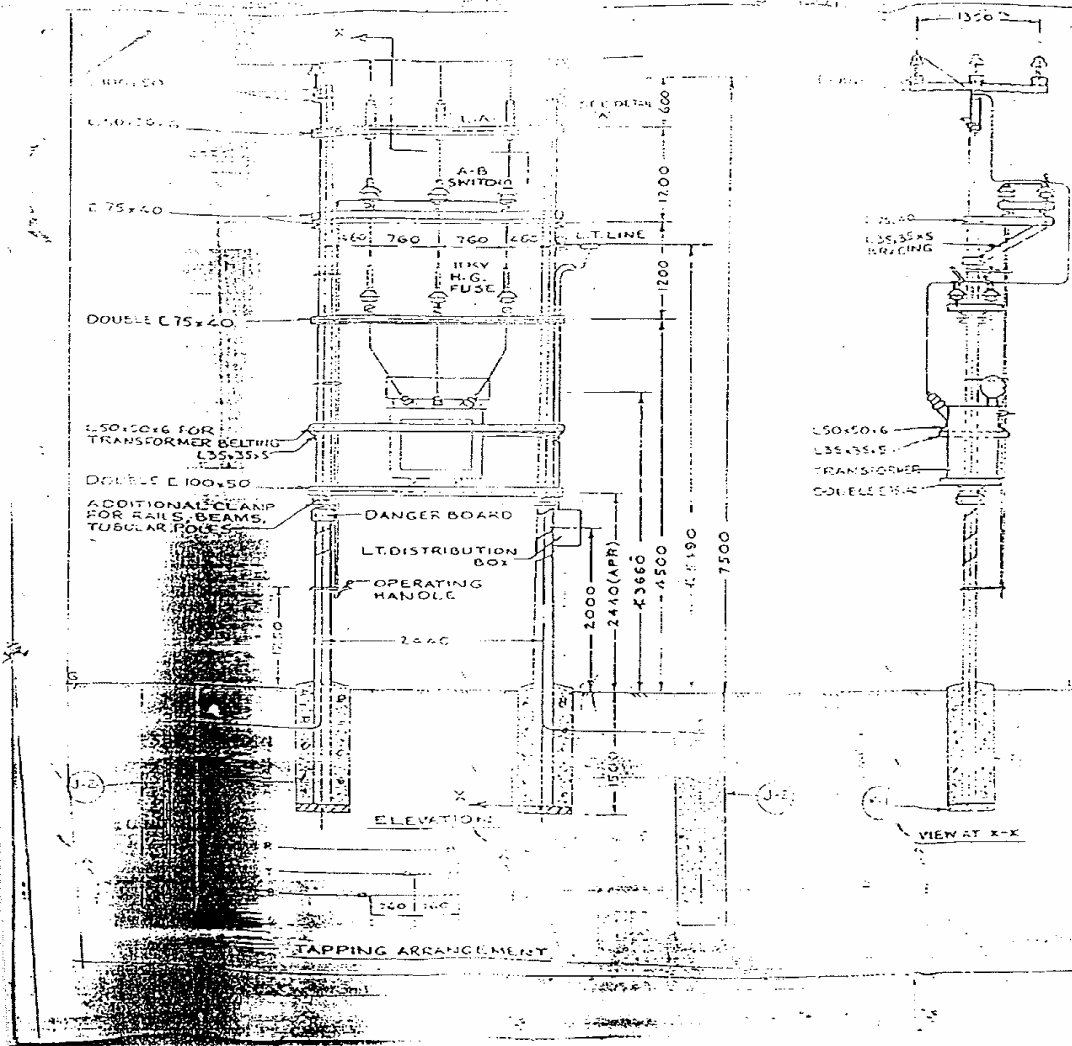

REC
CONSTRUCTION STANDARDS
F-3

BILL OF MATERIAL

SUPPORT - 3M	1
CHANNEL 100x50 - 2800 (APP.)	2
CHANNEL 100x50 - 1500 (APP.)	1
CHANNEL 75x40 - 2800 (APP.)	4
CHANNEL 75x40 - 1500 (APP.)	2
ANGLE 50x50x6 - 2800 (APP.)	2
ANGLE 35x35x5 - BRACING FOR SUPPORTING A-B SWITCH - 1000 (APP.)	2
ANGLE 35x35x5 - FOR TRANSFORMER BELTING	2
DISTRIBUTION TRANSFORMER	1
216 BREAK SWITCH (HORIZONTAL TYPE)	1 SET
H.C. FUSE UNIT - 3 PHASE	1 SET
11KV LIGHTNING ARRESTERS	3
DISTRIBUTION BOX	1
PIPE/ROD EARTHING (REFER J-Z)	AS REQD.
BASE PLATE (REFER K-1)	2
DANGER BOARD	1
CLAMPS, NUTS, BOLTS, BARBED WIRE ETC.	AS REQD.

NOTE:-
REFER F-5 FOR LOCATION OF
EARTH PITS.



ALL DIMENSIONS IN MM,
UNLESS OTHERWISE INDICATED.
11KV/433-250V
DISTRIBUTION SUB STATION
(FOR ON LINE LOCATION)
- ALONG LINE
SCALE: N.T.S. | SEPT. 2000

Client

Signature of the Bidder

REC
CONSTRUCTION STANDARDS
J-1

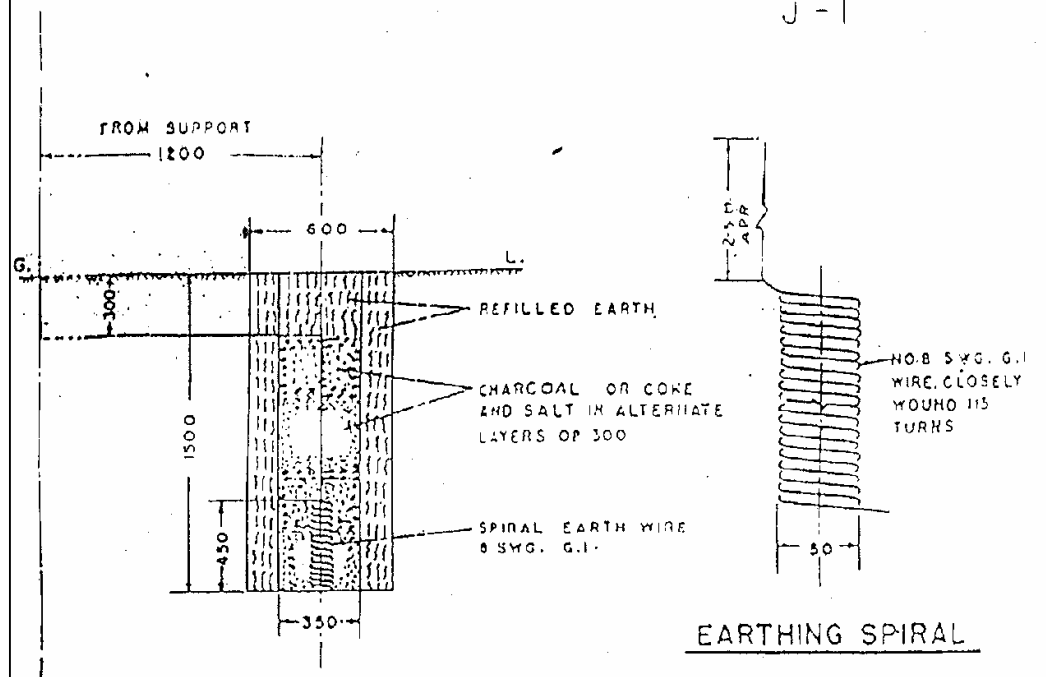

NOTE:-
FOR PIPE EARTHING REFER CONSTRUCTION
STANDARDS J-2.

ALL DIMENSIONS IN MM

COIL EARTHING

SCALE - H. T. S. SEPT. -

Annexure –'I'**List of projects in Jajpur District**

Sl. No.	Name of the Project	Type	Block	District	Improvement /Revival	Scope of work
1	Rangidaspur-I	RL	Badachana	Jajpur	Improvement	Supply of all required materials, erection of electric substation, drawl of HT / LT electric line. Providing three phase energy meter for each LIP, testing and commissioning to effect power supply to the Respective L.I. Projects (Sub-Project wise detail scope of work appended in annexure – I.)
2	Jagannathpur	RL	Badachana	Jajpur	Revival	
3	Sanabandala	RL	Badachana	Jajpur	Revival	
4	Rambhadeipur-I	RL	Badachana	Jajpur	Revival	
5	Rambhadeipur-II	RL	Badachana	Jajpur	Revival	
6	Bhubanpur-II	RL	Badachana	Jajpur	Revival	

Client**Signature of the Bidder**

Certificate of no Relationship

I/We hereby certify that I/We am/are not related to any officer of P.W.D of the rank of Asst. Engineer and above and any officer of the rank of Asst. Secretary and above in the W/R Dept. I/We am/are aware that if the facts subsequently proved to be false my/our contract will be rescinded with forfeiture of EMD and security deposit and I/We shall be liable to make good the loss or damage resulting from such cancellation.

I/We also note that, non-submission of the certificate will render my/our tender liable for rejection.

Signature of Contractor

Address.....
.....
.....
.....

Date: